

S300_Section & Stile Detail

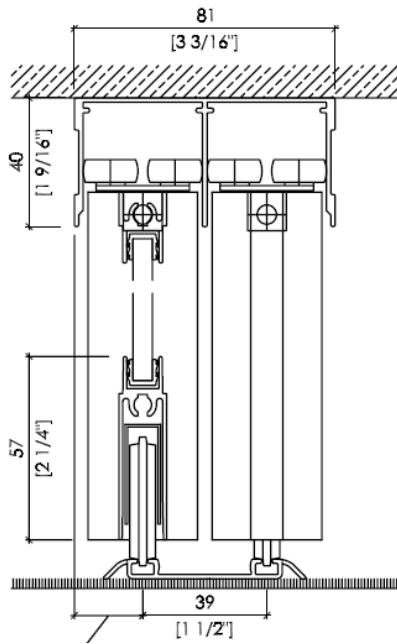

S300 Symmetrical

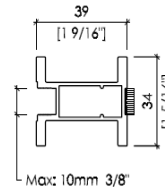

S300 Asymmetrical

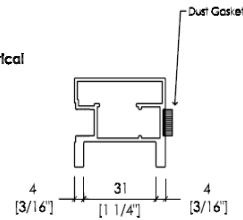

S300_Specifications

Top Track

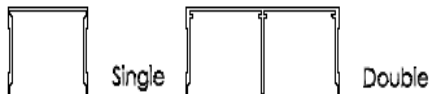

Dividing Rails

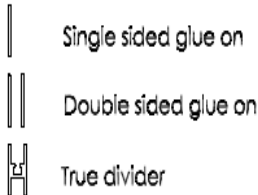

Bottom Track

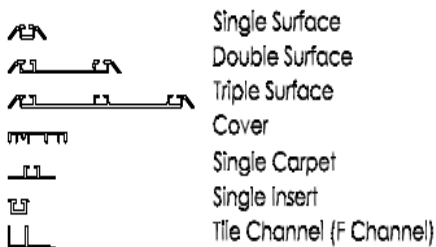

Finishes

Silver Anodized

Panel Materials

Max. size (w x h) / weight:

Frame Kit (no panel)

Panel Thickness, Glass max, 8mm
 Panel Thickness, other max, 10mm
 Silicone Gasket for panel size

390lbs / 180kgs

4mm, 5mm, 6mm, 8mm
 1/8", 3/16", 1/4", 5/16"

Solid Panels

MDF, Paint Grade 4' x 8'
 MDF, Custom Paint 4' x 8'
 Melamine 4' x 8'
 Clear Coat Veneer (cherry, walnut, oak) 4' x 8'
 Custom Stain Veneer (cherry, walnut, oak) 4' x 8'

Glass Panels

6mm Clear Laminated Glass 5' x 10'
 6mm Diffused White Laminated Glass 5' x 10'
 4mm Clear Tempered Glass 4' x 10'
 4mm Mirror w. Safety Backing 4' x 10'
 4mm MasterGlass (Tempered) 4' x 10'
 (Carre, Point, Ray, Linz)

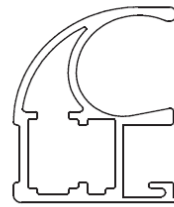

S751

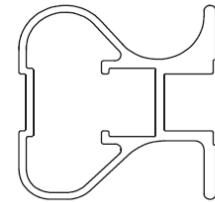

S753

S700

The S700 Series are EFI'S most price sensitive and hardworking profiles. These profiles are ideal for sliding door, closet, and room divider applications for larger contract jobs. They are available in two compact, useful stile configurations and offer great added-value to any project. The S700 series is part of the bottom-mounted 34mm system.

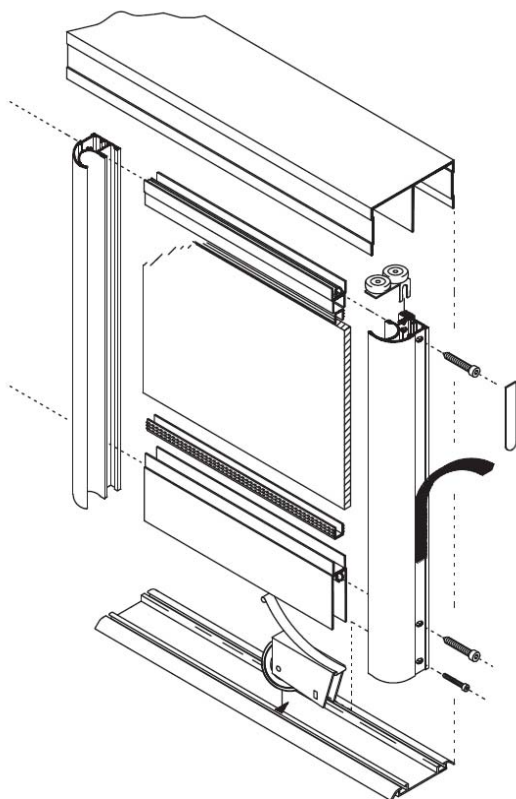

Isometric view S751

S700_Section & Stile Detail

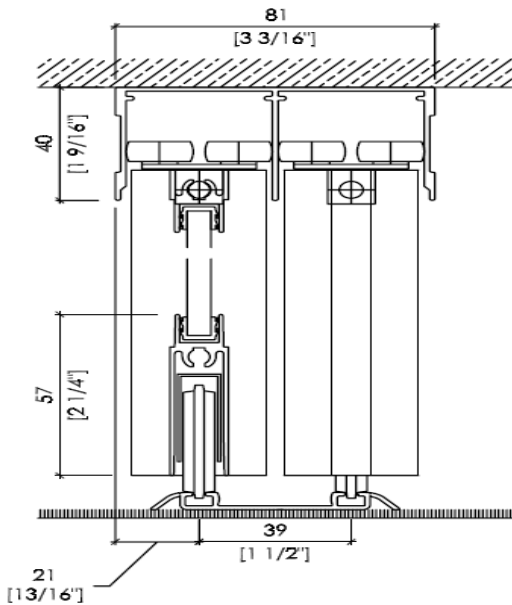

S751

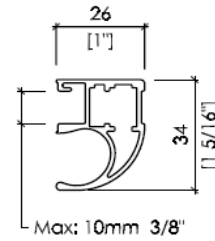

S753

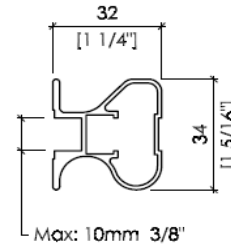

S700_Specifications

Top Track

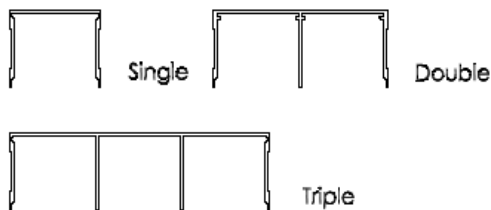

Dividing Rails

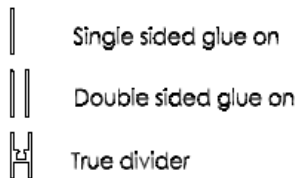

Bottom Track

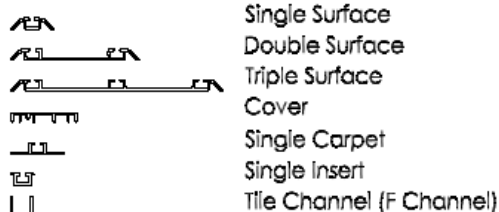

Finishes

Silver Anodized
Matte Gold Anodized*
Bronze Anodized*

White Powder Coat*
Matte Black Powder Coat*

* Special order only

Panel Materials

Max. size (w x h) / weight:

Frame Kit (no panel)

Panel Thickness, Glass max. 8mm
Panel Thickness, other max. 10mm
Silicone Gasket for panel size

390lbs / 180kgs

4mm, 5mm, 6mm, 8mm
1/8", 3/16", 1/4", 5/16"

Solid Panels

MDF, Paint Grade 4' x 8'
MDF, Custom Paint 4' x 8'
Melamine 4' x 8'
Clear Coat Veneer (cherry, walnut, oak) 4' x 8'
Custom Stain Veneer (cherry, walnut, oak) 4' x 8'

Glass Panels

6mm Clear Laminated Glass 5' x 10'
6mm Diffused White Laminated Glass 5' x 10'
4mm Clear Tempered Glass 4' x 10'
4mm Mirror w. Safety Backing 4' x 10'
4mm MasterGlass (Tempered) 4' x 10'
(Carre, Point, Ray, Linz)

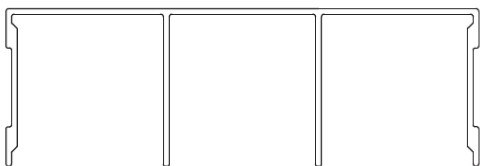
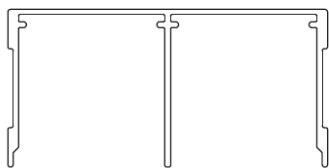
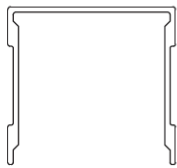

34mm Top Tracks

Single, double and triple top tracks are available as part of EFI's 34mm bottom-mounted sliding door system.

Cross section vertical: 34mm Top Tracks

34mm_Top Tracks

Single Top Track

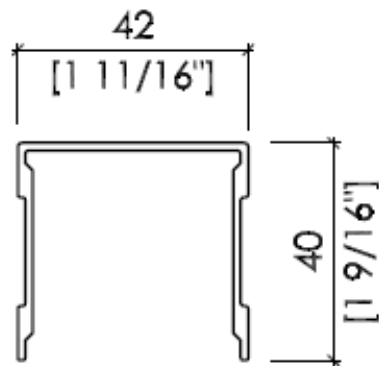



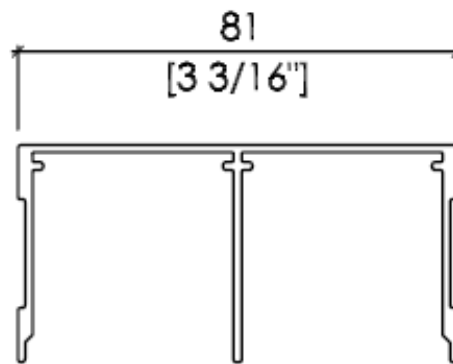

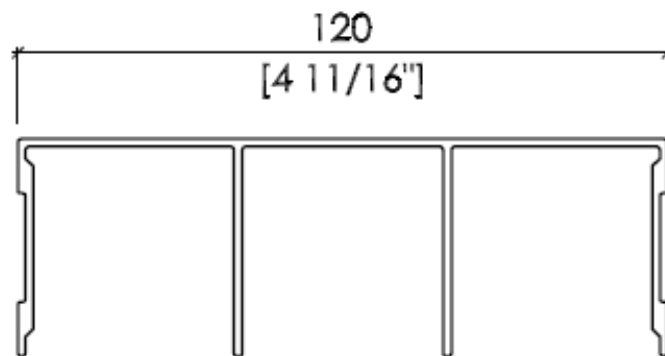

Double Top Track



Triple Top Track



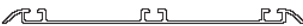

- | | |
|--|----------------|
|  | Single Surface |
|  | Single Carpet |
|  | Single Insert |
|  | Tile Channel |
| | |
|  | Double Surface |
|  | Cover |
|  | Triple Surface |

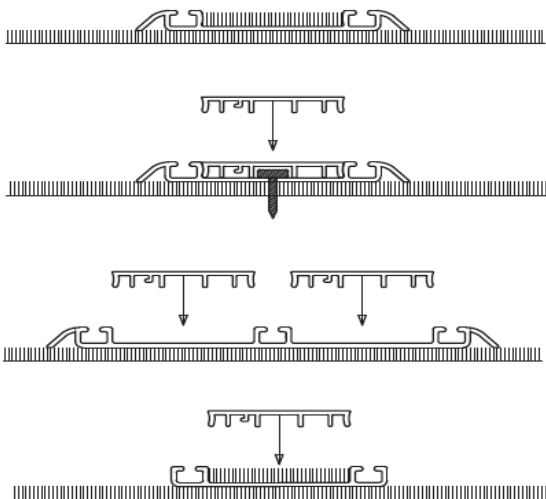
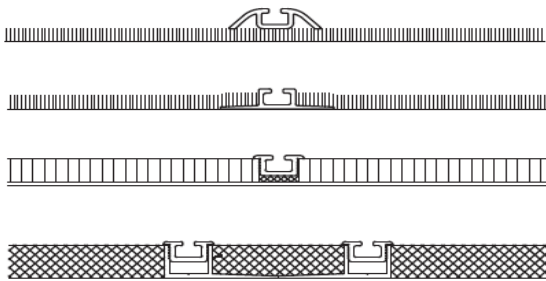

34 mm Bottom Tracks

The S300 is a smaller scaled EFI's bottom-mounted system comes with a large array of track options suitable to just about any substrate and door configuration. Our system includes surface-mounted single, double, and triple tracks and extrusions designed to be recessed into hardwood, tile, and carpeted floors for the smoothest of transitions.

Cross section vertical: 34mm Bottom Tracks

34mm_Bottom Tracks

Single Surface Bottom Track

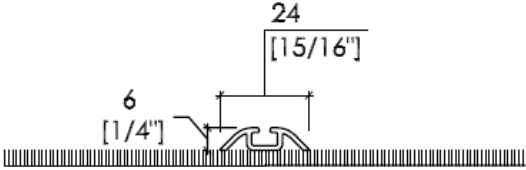

Double Surface Bottom Track

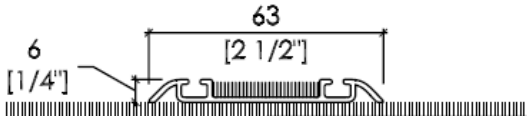

Triple Surface Bottom Track

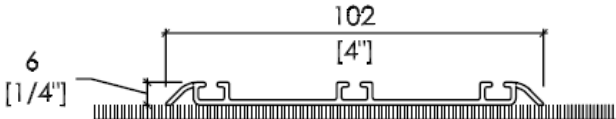

Single Carpet Bottom Track

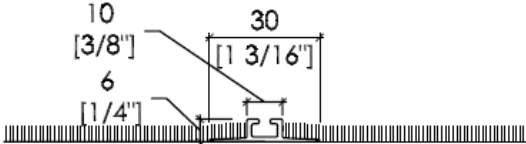

Single Insert Bottom Track

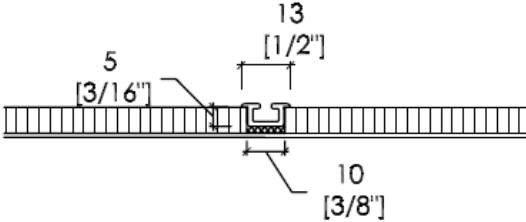

Double Insert Bottom Track

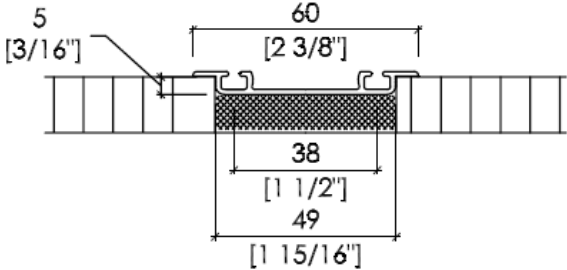

Tile Channel

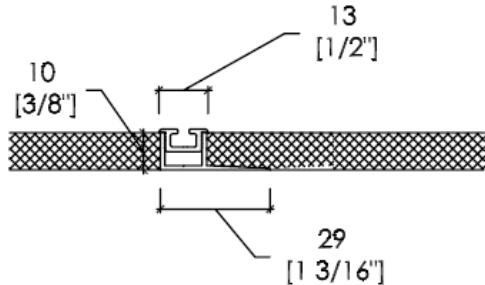

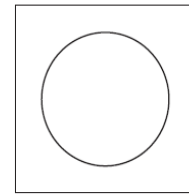

S300 Handle

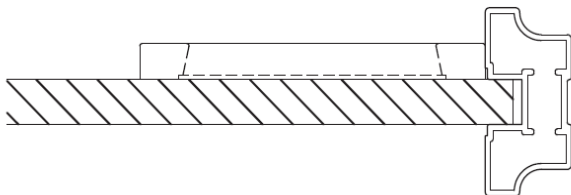
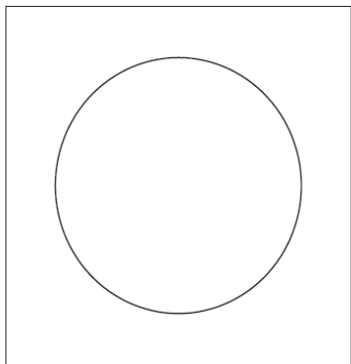

Cross section Horizontal; S300 Handle

34 mm
Accessories

EFI's bottom-mounted system comes with a large array of track options suitable to just about any substrate and door configuration. Our system includes surface-mounted single, double, and triple tracks and extrusions designed to be recessed into hardwood, tile, and carpeted floors for the smoothest of transitions.

34mm_Handles

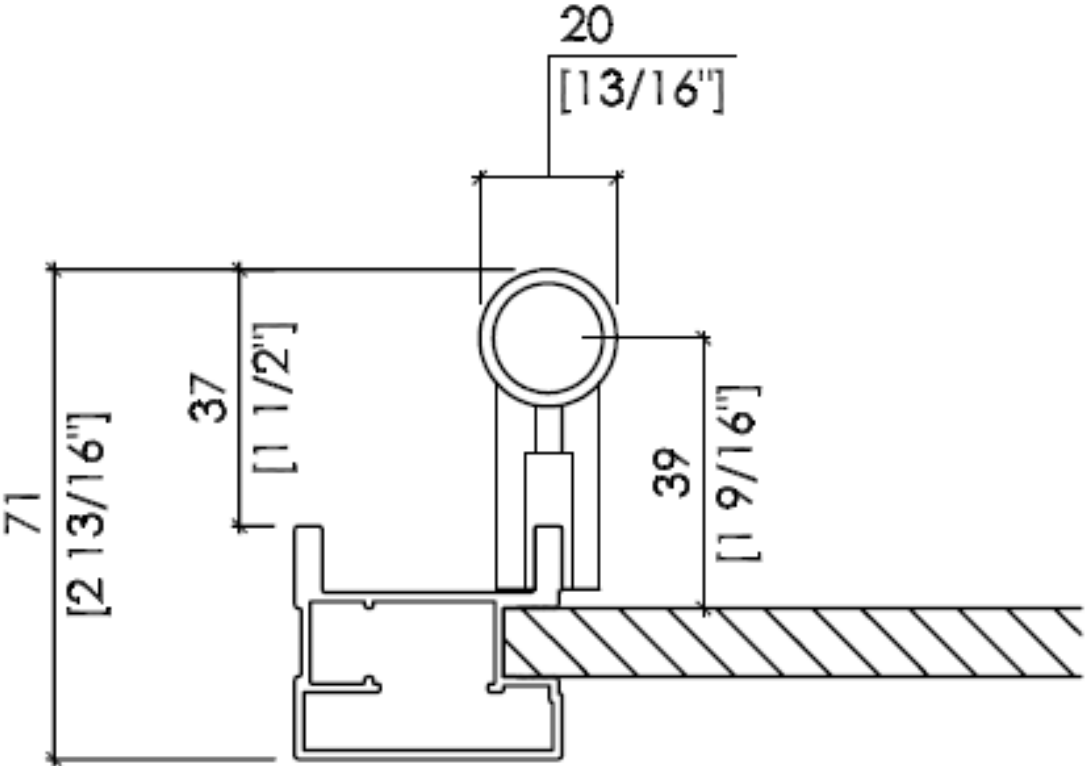

Brush Gasket



Glue-on Dividing Rail



Dividing Rail

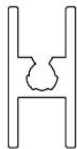

End Caps for Top Tracks
Aluminum

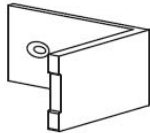

End Caps for Top Tracks
Aluminum with Stopper

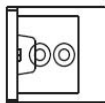
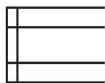

End Caps for Bottom Tracks,
Aluminum

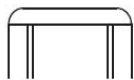

34mm Accessories

EFI's bottom-mounted system comes with a large array of track options suitable to just about any substrate and door configuration. Our system includes surface-mounted single, double, and triple tracks and extrusions designed to be recessed into hardwood, tile, and carpeted floors for the smoothest of transitions.

34mm_Accessories

End Caps for Top Tracks
(Surface/Wall Mounted)

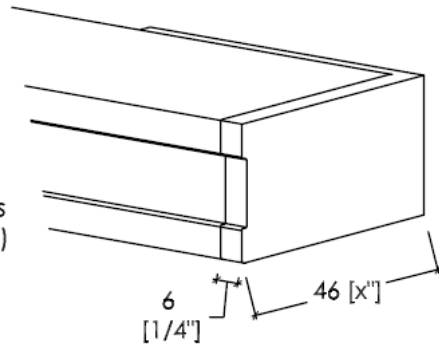

End Caps for Top Tracks
(Ceiling Mounted)

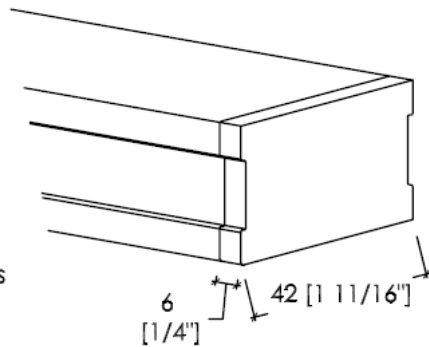

End Caps for Bottom Tracks
- Single

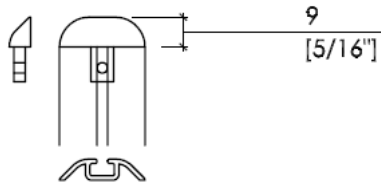

- Double

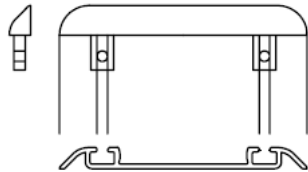

- Triple

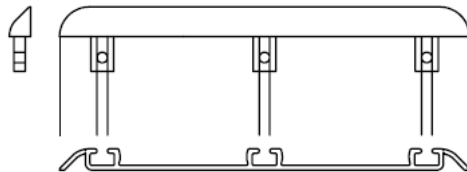

Glue-on Dividing Rail

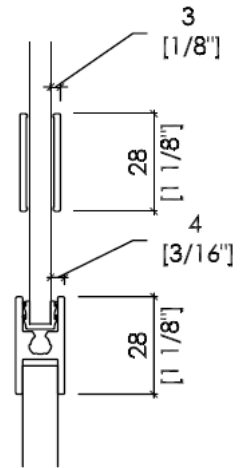

True Dividing Rail